

GENERAL NOTES

- 1.) Concrete $f_c = 4,000$ psi After 28 Days Minimum
- 2.) Broom Finish Supplied
- 3.) Blocks and Angles Attached to Poured Foundation by Phoenix Precast
- 4.) Optional Concrete Slab, Sono Tubes or Compacted Crushed Gravel by Others
- 5.) Step Rise: 7"
- 6.) Standard Landing: 5' x 4'
- 7.) Tread Depth: 12"

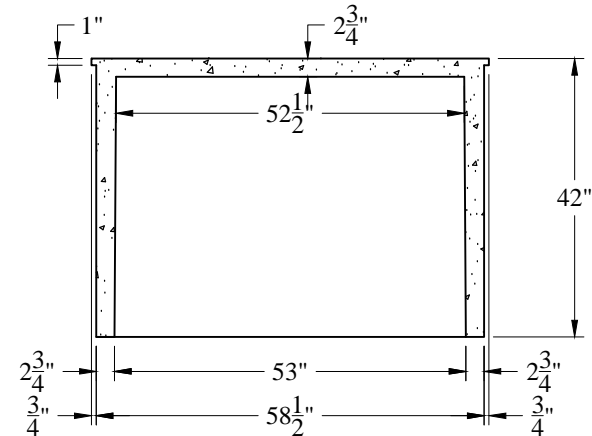

Phoenix Precast Products

Phoenix Precast Products

Phoenix
Precast
Products

5' Wide Stair
With 6 Risers

P/N: PS-5WX6R